



HP
SCAFFOLD
www.huapumachine.com



HP SCAFFOLDING FORMWORK & ACCESSORIES

日照市华普机械有限公司
RIZHAO HUAPU MACHINERY CO.,LTD

日照市华普机械有限公司
RIZHAO HUAPU MACHINERY CO.,LTD

Add: Rizhao, Shandong Province, China

Tel : 86-633 8267688/8251122

Mobile/Wechat : 86-13506336706

Web: www.huapumachine.com
www.hpscaffold.com

Email: Louhai3@hotmail.com

Cole@huapumachine.com



中国·日照
RIZHAO·CHINA



www.huapumachine.com

Company Profile

We are a professional manufacturer of scaffolding and formwork parts with their accessories since 1996. We provide a wide range of high-quality products and the best after-sales service at reasonable prices.

Our products are used in the field of construction and concrete to connect, support, or protect. Our products include scaffolding frames, heavy and light duty props, base jacks, guardrails, various coupling pins, rapid clamps and tensioners, wing nuts, formwork clamps and so on. Our products are not only safe and reliable, but also durable and popular. Besides, we have the in-house capability to manufacture customized products to meet your unique specifications and drawings.

Our employees have all been trained by mechanical engineers, and the experts have also passed the test before taking up the job. In addition, after the materials used for production arrive at the workshop, they will be checked for chemical composition and physical properties. The finished goods will be tested for the loading capacity and assemble situation for each order. All inspections we will send to customers and be recorded by QC, which will ensure our stability and high quality. It is worth mentioning that we strictly abide by the quality system ISO 9002.

We have established relationships with clients from all over the world: Europe Union, USA, Canada, Brazil, Australia, Middle East, and Africa. We can deliver quickly and reliably to destinations throughout the world.

Our mission is to establish long-term business relationships with our clients. We always adhere to the basic principle of equality and mutual benefit.

Your satisfaction is always our first goal!



SCAFFOLDING FRAMES



SCAFFOLDING FRAMES

S-Style Walk Thru Frames

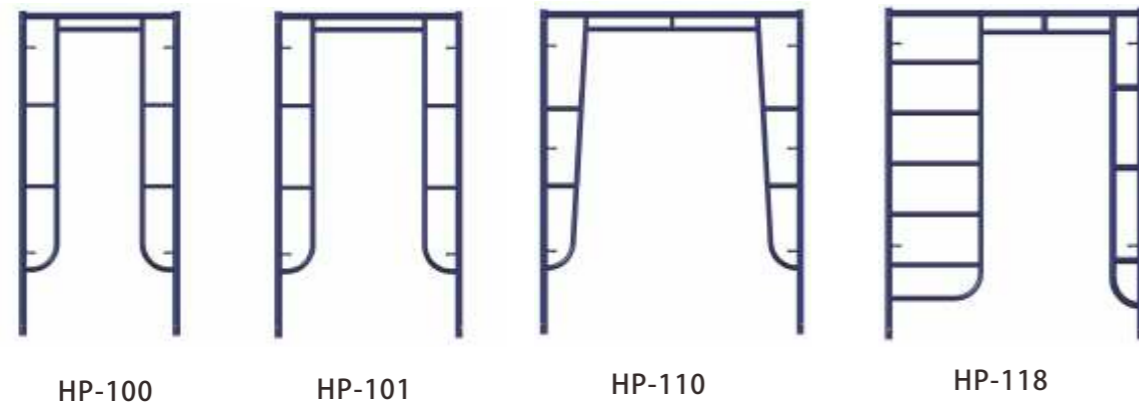

Item No	Description	Leg Tube	Weight(lbs)
HP-100	6'4"HX3'W	1.69"X0.095"	38.05
HP-101	6'4"HX42"W	1.69"X0.095"	39.30
HP-110	6'4"HX5'W	1.69"X0.095"	43.55
HP-118	6'4"HX5'W	1.69"X0.095"	53.25

S-Style Mason Frames

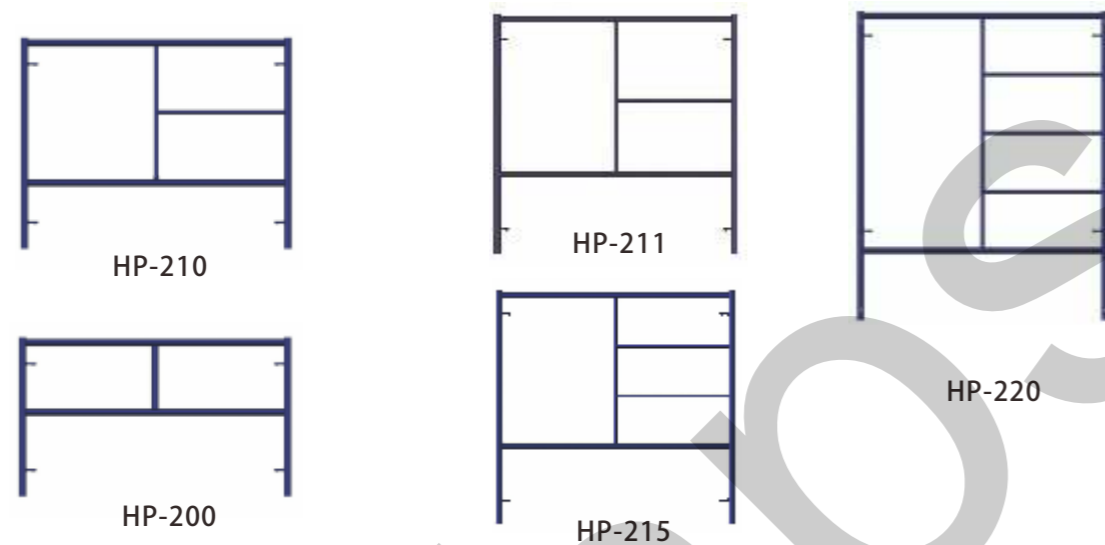

Item No	Description	Leg Tube	Weight(lbs)
HP-200	3'HX5'W	1.69"X0.095"	25.70
HP-210	4'HX5'W	1.69"X0.095"	29.50
HP-211	5'HX5'W	1.69"X0.095"	34.78
HP-215	5'HX5'W	1.69"X0.095"	38.50
HP-220	6'4"HX5'W	1.69"X0.095"	45.77

Box Frames

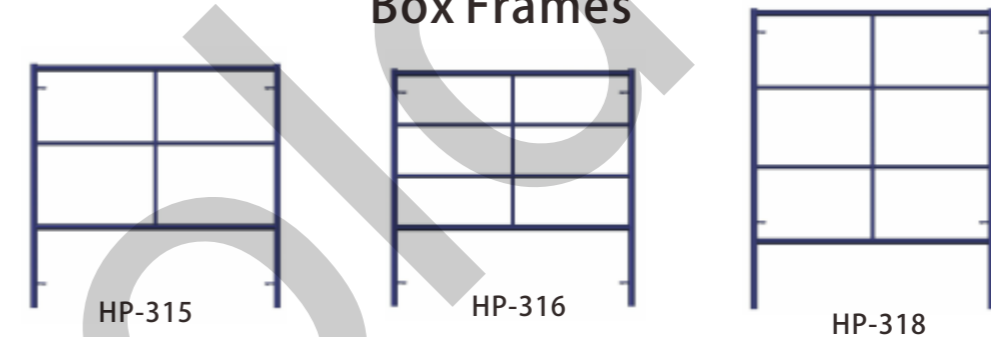

Item No	Description	Leg Tube	Weight(lbs)
HP-315	5'1"HX5'W	1.625"X0.09"	41
HP-316	5'HX5'W	1.625"X0.09"	44
HP-318	6'8"HX5'W	1.625"X0.09"	55

Shoring Frames



Item No	Description	Leg Tube	Weight(lbs)
HP-401	4'HX4'W	2.375"X0.156"	49.88
HP-403	5'HX4'W	2.375"X0.156"	56.90
HP-406	6'HX4'W	2.375"X0.156"	65.86

Screw Jack



SCAFFOLDING&FORMWORK ACCESSORIES

Lock



Coupling Pin



Clips & Pins



Base Plates & U-Heads

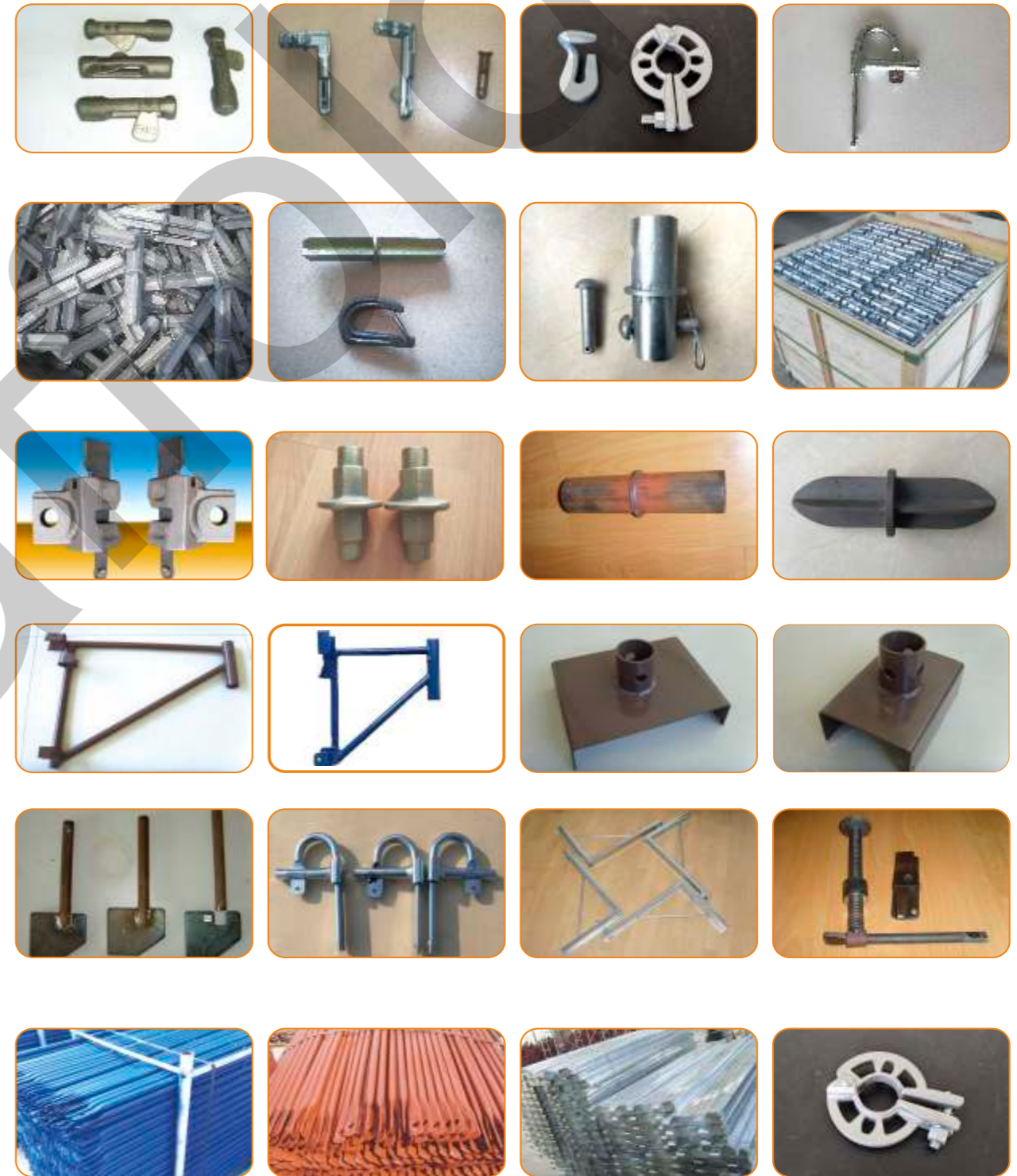

BASE JACK

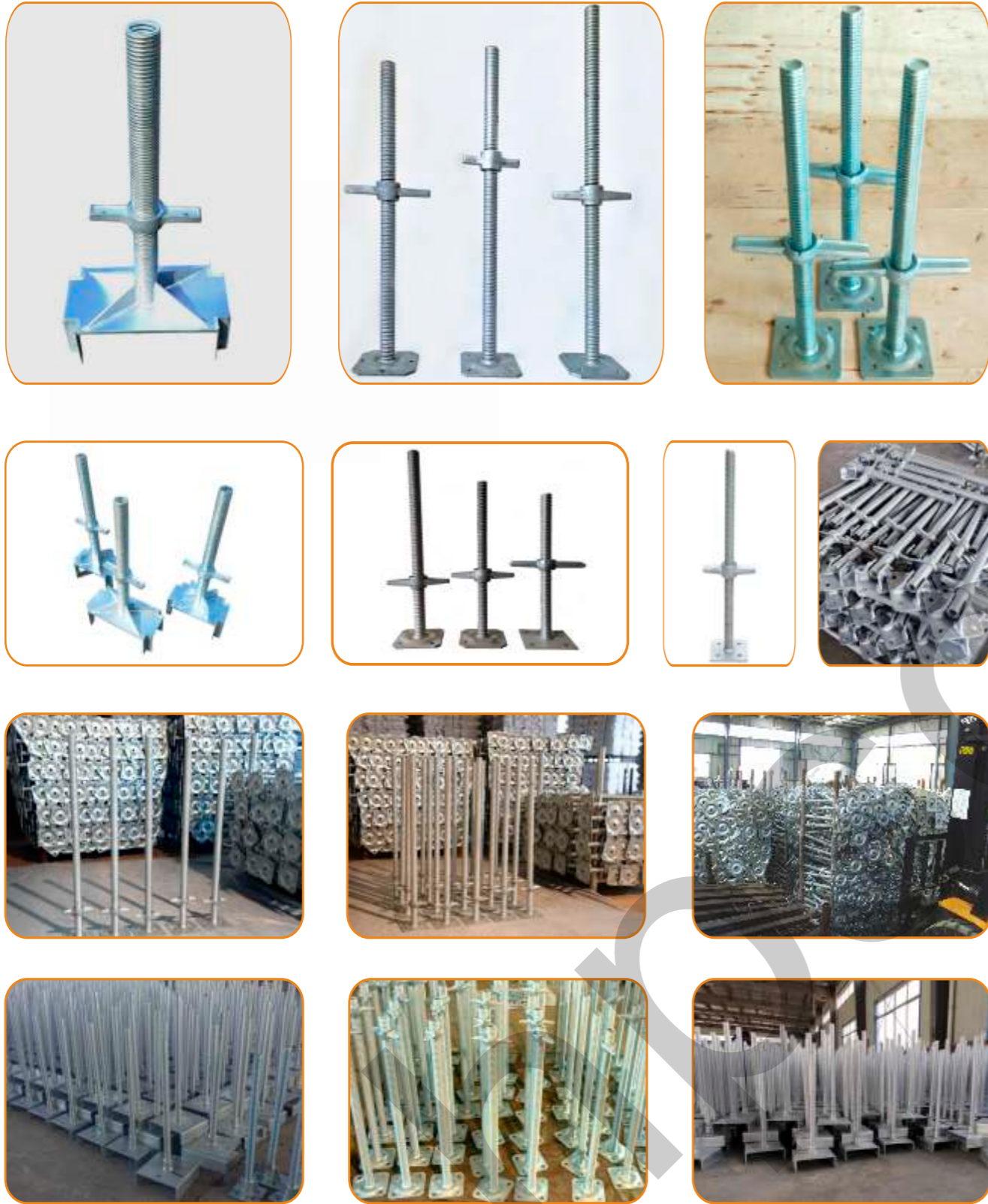

RAPID CLAMP & TENSIONER



FORMWORK NUT

Specification:

Dywidag thread DW15mm, DW20mm

Base plate D60mm, D70mm, D80mm, D90mm, D100mm, D110mm, D120mm, D130mm

Single nut or combine, Finished: Galvanizing / self color



COUPLERS

Specification:

Work for connecting tube 42*48.3mm, 48.3*48.3mm, 48.3*60mm, 60*76.2mm, 60*89mm

Finished: Galvanizing / Hot dip galvanizing



Rod Clamps



Rod Clamp



Rod Clamps



Rod Clamps



German Coupler Swivel



German Coupler Fixed



German Couplers



German Couplers



British Coupler Swivel



British Coupler Fixed



British Couplers



British Couplers



American Coupler Fixed



American Coupler Swivel



Italian Coupler Fixed



Italian Couplers Swivel



Ladder Coupler



Toe Board Clamp



Fence Clamp



Putlog Coupler



British Coupler



British Coupler



German Coupler



British Couplers



Double Coupler

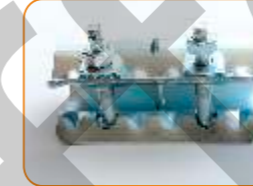

Outer Coupler



Grider Coupler



T Coupler



Inner Pin



Triangle Coupler



GUARDRAIL&WALL BAR



PROPS & ACCESSORIES

Specification:

Tube diameter: 40/48mm, 48/57mm, 48/60mm, 60/76.2mm, 76.2/89mm

Popular work length: 1.6-3.0m, 2.0-3.5m, 2.2-4.0m

Finished: paint, powder coat / galvanizing / Hot dip galvanizing

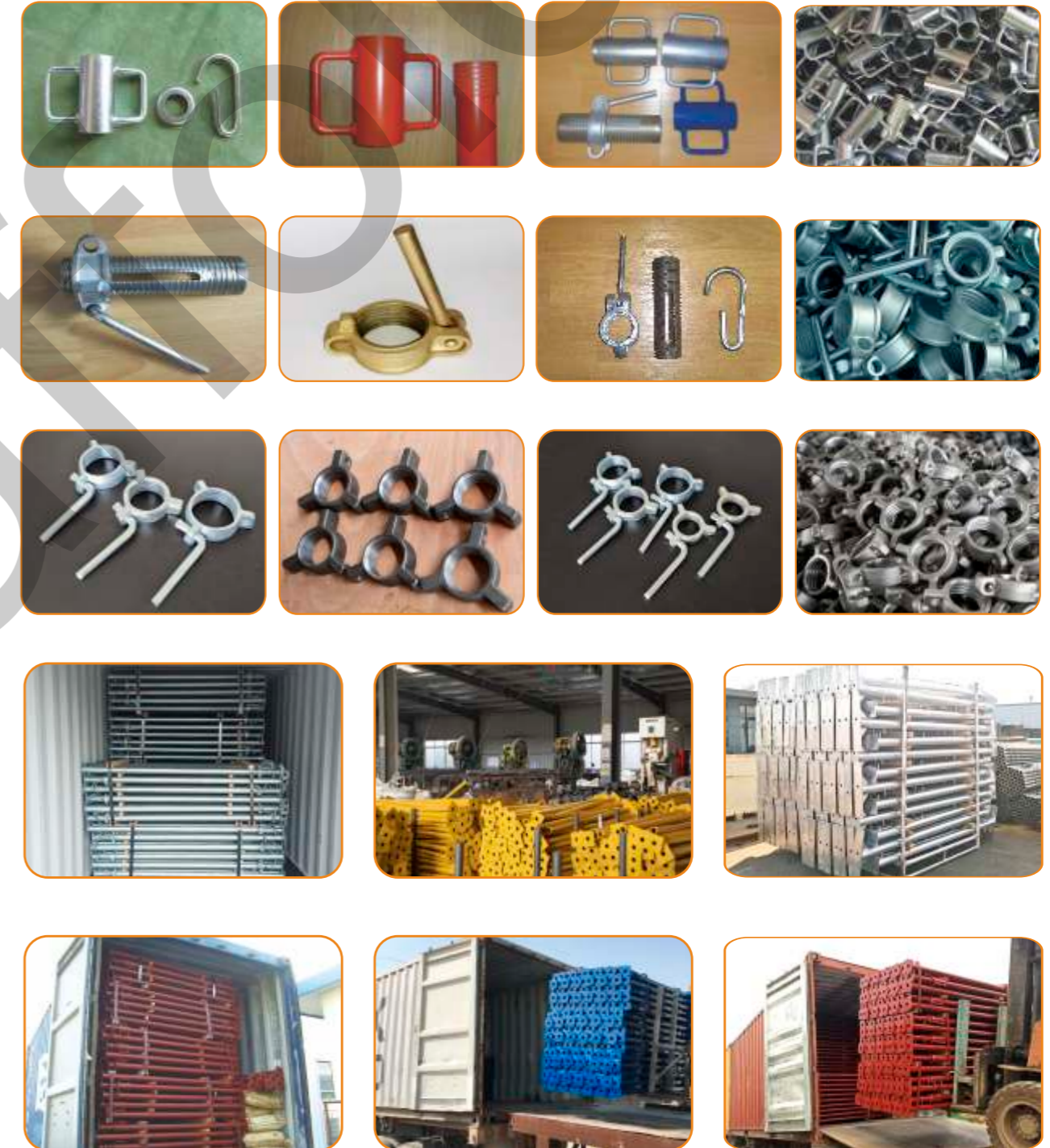

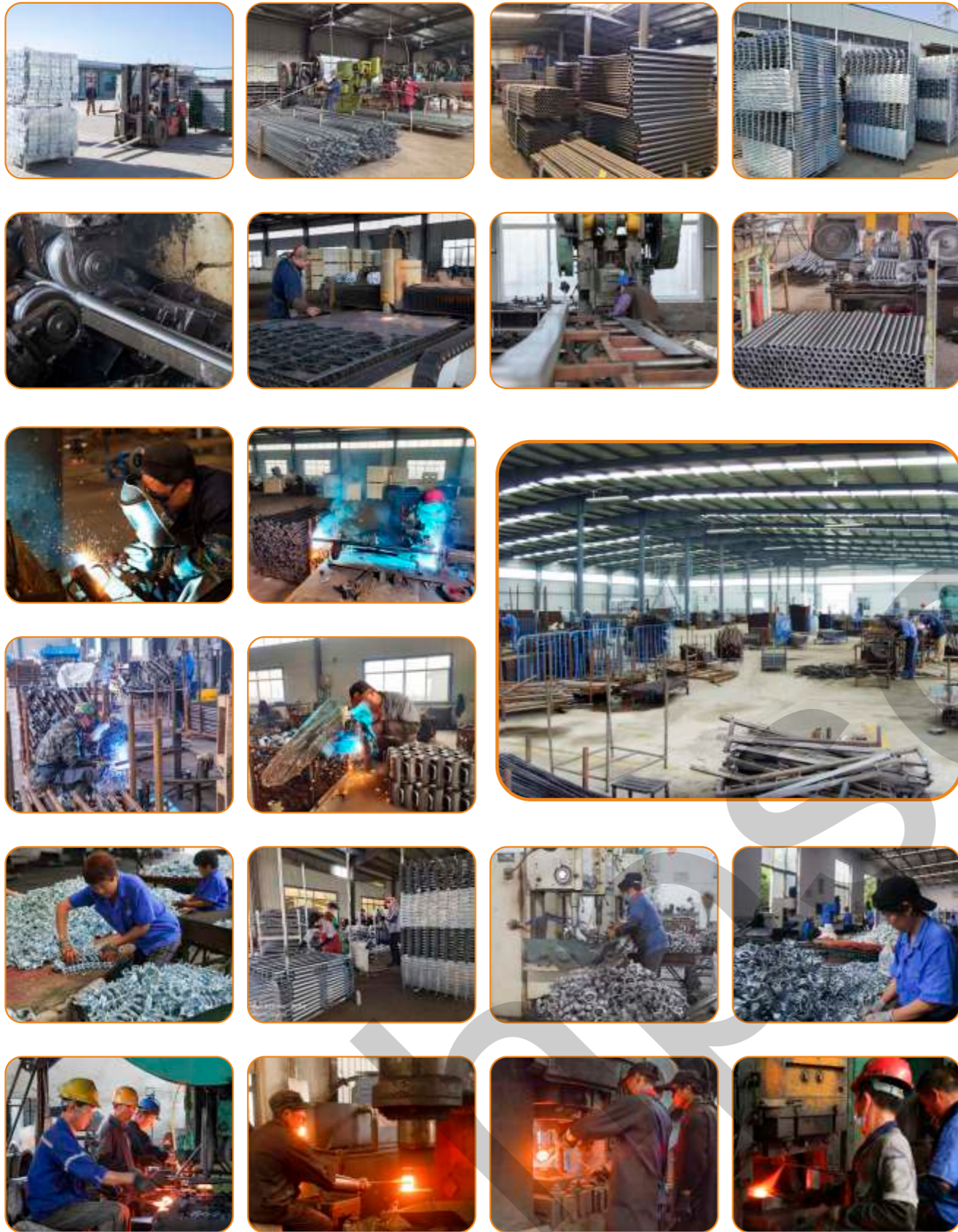

TESTING

EXHIBITION



Strength Test



Loading Test

Loading Test

Impact Test

Loading Test

Loading Test

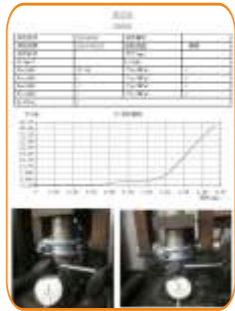

Hardness Test

Slip resistance Test

Broken Test

Torque Test

Strength Test



H.D.G thickness Test

Strength Test

Slip resistance Test

Strength Test

